



Standard Practice for Modified Salt Spray (Fog) Testing¹

This standard is issued under the fixed designation G85; the number immediately following the designation indicates the year of original adoption or, in the case of revision, the year of last revision. A number in parentheses indicates the year of last reappraisal. A superscript epsilon (ϵ) indicates an editorial change since the last revision or reappraisal.

This standard has been approved for use by agencies of the Department of Defense.

1. Scope

1.1 This practice covers and sets forth conditions for five modifications in salt spray (fog) testing for specification purposes. These are in chronological order of their development:

- 1.1.1 *Annex A1*, acetic acid-salt spray test, continuous.
- 1.1.2 *Annex A2*, cyclic acidified salt spray test.
- 1.1.3 *Annex A3*, seawater acidified test, cyclic (SWAAT).
- 1.1.4 *Annex A4*, SO₂ salt spray test, cyclic.
- 1.1.5 *Annex A5*, dilute electrolyte cyclic fog dry test.

1.2 This practice does not prescribe the type of modification, test specimen or exposure periods to be used for a specific product, nor the interpretation to be given to the results.

1.3 The values stated in SI units are to be regarded as standard. No other units of measurement are included in this standard.

1.3.1 *Exception*—Fahrenheit temperature values are given for information only throughout this practice.

1.4 *This standard does not purport to address all of the safety concerns, if any, associated with its use. It is the responsibility of the user of this standard to consult and establish appropriate safety and health practices and determine the applicability of regulatory limitations prior to use.*

2. Referenced Documents

2.1 *ASTM Standards*:²

- [B117 Practice for Operating Salt Spray \(Fog\) Apparatus](#)
- [D609 Practice for Preparation of Cold-Rolled Steel Panels for Testing Paint, Varnish, Conversion Coatings, and Related Coating Products](#)
- [D1141 Practice for the Preparation of Substitute Ocean Water](#)

¹ This practice is under the jurisdiction of ASTM Committee G01 on Corrosion of Metals and is the direct responsibility of Subcommittee G01.05 on Laboratory Corrosion Tests.

Current edition approved May 1, 2011. Published August 2011. Originally approved in 1985. Last previous edition approved in 2009 as G85-09. DOI: 10.1520/G0085-11.

² For referenced ASTM standards, visit the ASTM website, www.astm.org, or contact ASTM Customer Service at service@astm.org. For *Annual Book of ASTM Standards* volume information, refer to the standard's Document Summary page on the ASTM website.

[D1193 Specification for Reagent Water](#)

[D1654 Test Method for Evaluation of Painted or Coated Specimens Subjected to Corrosive Environments](#)

[E70 Test Method for pH of Aqueous Solutions With the Glass Electrode](#)

3. Significance and Use

3.1 This practice is applicable to ferrous and nonferrous metals; also organic and inorganic coatings. The variations described herein are useful when a different or more corrosive environment than the salt fog described in Practice B117 is desired.

4. Apparatus

4.1 *Cabinet*:

4.1.1 The apparatus required for salt spray (fog) testing consists of a fog chamber, a salt solution reservoir, a supply of suitably conditioned compressed air, one or more atomizing nozzles, specimen supports, provision for heating the chamber, and necessary means of control. The size and detailed construction of the cabinet are optional, provided the conditions obtained meet the requirements of this practice. The material of construction shall be such that it will not affect the corrosiveness of the fog. Suitable apparatus that may be used to obtain these conditions is described in Appendix X1 of Practice B117 with necessary modifications described in each annex of this practice.

4.1.2 Design the cabinet so that drops of solution that accumulate on the ceiling or cover of the chamber do not fall on the specimens being tested. Do not return drops of solution that fall from the specimens to the solution reservoir for respraying.

4.1.3 Equip the cabinet with one or more timing devices to provide for intermittent spraying or periodic introduction of a gas, or both.

4.2 *Air Supply*:

4.2.1 Make sure the compressed air supply to the nozzle or nozzles for atomizing the salt solution is free of oil and dirt and maintain the air supply between 69 and 172 kPa (10 and 25 psi).

NOTE 1—The air supply may be freed of oil and dirt by passing it through a water scrubber or at least 610 mm (2 ft) of suitable cleaning material such as asbestos, sheep's wool, or activated alumina.

4.2.2 Temperature in the saturator tower (bubble tower) varies depending on the test method used.

4.3 Conditions in Salt-Spray Chamber:

4.3.1 *Temperature*—The temperature in the exposure zone varies with the test method used. For recommended exposure zone temperatures for the various methods, see the annexes in this practice. Each set point and its tolerance represents an operational control point for equilibrium conditions at a single location in the cabinet which may not necessarily represent the uniformity of conditions throughout the cabinet. Record the temperature within the exposure zone of the closed cabinet at least twice a day at least 7 h apart (except on weekends and holidays, when the salt spray test is not interrupted for exposing, rearranging, or removing test specimens or to check and replenish the solution in the reservoir).

NOTE 2—Suitable methods to record the temperature are a continuous recording device or a thermometer which can be read from outside the closed cabinet. Obtain the recorded temperature with the salt spray chamber closed to avoid a false low reading because of wet-bulb effect when the chamber is open.

4.3.2 *Atomization and Quantity of Fog*—Place at least two clean fog collectors within the exposure zone so that no drops of solution from the test specimens or any other source can be collected. Position the collectors in the proximity of the test specimens, one nearest to any nozzle and the other farthest from all nozzles. Make sure that for each 80 cm² of horizontal-collecting area fog accumulates in each collector from 1.0 to 2.0 mL of solution per hour based on an average run of at least 16 h continuous spray.

NOTE 3—Suitable collecting devices are glass funnels with the stems inserted through stoppers into graduated cylinders or crystallizing dishes. Funnels and dishes with a diameter of 100 mm have an area of about 80 cm².

4.3.3 Direct or baffle the nozzle or nozzles so that none of the spray can impinge directly on the test specimens.

5. Test Specimens

5.1 Define the type and number of test specimens to be used, as well as the criteria for the evaluation of the test results in the specifications covering the material or product being tested or upon mutual agreement between the purchaser and the seller.

5.2 Preparation of Test Specimens:

5.2.1 Clean metallic and metallic-coated specimens. The cleaning method is optional depending on the nature of the surface and the contaminants; however, when using a cleaning method do not include in the contents abrasives other than a paste of pure magnesium oxide nor of solvents which may form corrosive or inhibitive films. The use of nitric acid solution for the chemical cleaning, or passivation, of stainless steel specimens is permissible when agreed upon between the purchaser and the seller. Take care that specimens are not recontaminated after cleaning by excessive or careless handling.

5.2.2 Prepare specimens for evaluation of paints and other organic coatings in accordance with applicable specification(s) for the material(s) being tested, or as agreed upon between the purchaser and supplier. Otherwise, make sure the test specimens consist of steel meeting the requirements of Practice

D609; clean and prepare the specimens for coating in accordance with applicable procedure of Practice D609.

5.2.3 Whenever it is desired to determine the development of corrosion from an abraded area in the paint or organic coating, make a scratch or scribed line through the coating with a sharp instrument so that the underlying metal is exposed before testing. Use the conditions of making the scratch as defined in Test Method D1654, unless otherwise agreed upon between the purchaser and seller.

5.2.4 Protect the cut edges of plated, coated, or duplex materials and areas that contain identification marks or that are in contact with the racks or supports with a suitable coating that is stable under the conditions of the test, such as ceresin wax, unless otherwise specified.

NOTE 4—Should it be desirable to cut test specimens from parts or from preplated, painted, or otherwise coated-steel sheet, protect the cut edges by coating them with paint, wax, tape, or other effective media so that the development of preferential attack or a galvanic effect between such edges and the adjacent plated or otherwise coated-metal surfaces, is prevented.

6. Salt Solutions

6.1 Make the salt solutions by using either synthetic sea salt in accordance with Practice D1141 or sodium chloride in accordance with Practice B117, unless otherwise specified in the appropriate annex. Make-up water shall be distilled or deionized water conforming to Type IV water in Specification D1193 (except that for this practice, limits for chlorides and sodium may be ignored).

6.2 *Synthetic Sea Salt Solution* (see Annex A3)—Make the salt solution so that it consists of 42 g of synthetic sea salt in accordance with Practice D1141 per litre of solution (see Note 5).

6.3 *Sodium Chloride Solution* (Except Annex A3 and Annex A5):

Prepare the salt solution by dissolving 5 ± 1 parts by weight of sodium chloride in 95 parts of water conforming to Type IV water in Specification D1193 (except that for this practice, limits for chlorides and sodium may be ignored) containing not more than 200 ppm of total solids (see Note 5). Halides (Bromide, Fluoride, and Iodide) other than Chloride shall constitute less than 0.1 % by mass of the salt content. Copper content shall be less than 0.3 ppm by mass. Sodium chloride that has had anti-caking agents added shall not be used because such agents may act as corrosion inhibitors (see Note 6). See Table 1 for a listing of these impurity restrictions. Upon agreement between the purchaser and the seller, analysis may be required and limits established for elements or compounds not specified in the chemical composition given above.

TABLE 1 Maximum Allowable Limits for Impurity Levels in Sodium Chloride

Impurity Description	Allowable Amount
Total Impurities	≤0.3%
Halides (Bromide, Fluoride and Iodide) excluding Chloride	< 0.1 %
Copper	< 0.3 ppm
Anti-caking Agents	None Added

TABLE 2 Temperature versus Density Data

Temperature, °C (°F)	Density, g/cm ³		
	4% Salt Concentration	5% Salt Concentration	6% Salt Concentration
20 (68)	1.025758	1.032360	1.038867
21 (69.8)	1.025480	1.032067	1.038560
22 (71.6)	1.025193	1.031766	1.038245
23 (73.4)	1.024899	1.031458	1.037924
24 (75.2)	1.024596	1.031142	1.037596
25 (77)	1.024286	1.030819	1.037261
26 (78.8)	1.023969	1.030489	1.036919
27 (80.6)	1.023643	1.030152	1.036570
28 (82.4)	1.023311	1.029808	1.036215
29 (84.2)	1.022971	1.029457	1.035853
30 (86)	1.022624	1.029099	1.035485
31 (87.8)	1.022270	1.028735	1.035110
32 (89.6)	1.021910	1.028364	1.034729
33 (91.4)	1.021542	1.027986	1.034343
34 (93.2)	1.021168	1.027602	1.033950
35 (95)	1.020787	1.027212	1.033551
36 (96.8)	1.020399	1.026816	1.033146
37 (98.6)	1.020006	1.026413	1.032735
38 (100.4)	1.019605	1.026005	1.032319
39 (102.2)	1.019199	1.025590	1.031897
40 (104)	1.018786	1.025170	1.031469

NOTE 5—The specific gravity of salt solution will change with temperature. Table 2 shows salt concentration and density versus temperature and can be used to determine if the sample measured is within specification. The sample to be measured may be a composite sample from multiple fog-collecting devices within a single cabinet, if necessary, to obtain sufficient solution volume for measurement.

Table 2³ shows the salt concentration and salt density of 4%, 5%, and 6% salt solution between 20 and 40°C. A measurement that falls within the range between 4 and 6% is acceptable.

It is important to understand the equipment being used to measure specific gravity. One common practice for specific gravity measurement is the use of a hydrometer. If used, careful attention to the hydrometer type is important as most are manufactured and calibrated for measurements at 15.6°C. Since salt density is temperature dependent an offset will be necessary to make an accurate measurement at other temperatures. Contact the hydrometer manufacturer to find the proper offset for the hydrometer being used.

NOTE 6—A measurable limit for anti-caking agents is not being defined as a result of how salt is manufactured. During salt manufacturing, it is common practice to create salt slurry from the raw salt mined. A crystallization process then captures the pure salt from this slurry. Some naturally occurring anti-caking agents can be formed in this process and are not removed from the resultant product. Avoid salt products where extra anti-caking agents are added. Additionally, when doing an elemental analysis of salt there can be trace elements present that either stand alone or are part of an anti-caking agent. It is not economically feasible to know where such elements came from due to the long list of possible anti-caking agents that would have to be tested. Therefore a salt product that meets the impurity, halide, and copper limits with no anti-caking agents added is acceptable. The salt supplier can provide an analysis of the salt with a statement indicating that anti-caking agents were not added to the product.

6.4 The pH of the salt solutions will vary depending on the test method used. Before the solution is atomized, free it of suspended solids (see Note 7). Take the pH measurements electrometrically at 25°C (77°F) using a glass electrode with a saturated potassium chloride bridge in accordance with Test Method E70.

NOTE 7—The freshly prepared salt solution may be filtered or decanted before it is placed in the reservoir, or the end of the tube leading from the solution to the atomizer may be covered with a double layer of cheesecloth or suitable nonmetallic filter cloth to prevent plugging of the nozzle.

7. Procedure

7.1 Position of Specimens During Test:

7.1.1 Unless otherwise specified, support or suspend the specimens between 6 and 45° from the vertical, and preferably parallel to the principal direction of horizontal flow of fog through the chamber, based upon the dominant surface being tested. Note that test severity increases as angle from the vertical increases.

7.1.2 Do not allow contact of the specimens between each other, between any metallic material, or between any material capable of acting as a wick.

7.1.3 Place each specimen so as to permit free settling of fog on all specimens. A minimum spacing between specimens of 30 mm is recommended.

7.1.4 Do not permit the salt solution from one specimen to drip on any other specimen.

7.1.5 It is recommended that placement of replicate specimens be randomized to avoid possible bias caused by difference in spray patterns. Individual specimens may also be rotated daily for the same reason.

7.1.6 Suitable materials for the construction or coating of racks and supports are glass, rubber, plastic, or suitably coated wood. Do not use bare metal. Support specimens preferably from the bottom or the side. Slotted wooden, laminated plastic, or inert plastic strips are suitable for the support of flat panels. Suspension from glass hooks or waxed string may be used as long as the specified position of the specimens is obtained, and, if necessary, by means of secondary support at the bottom of the specimens.

7.2 Continuity of Test—Unless otherwise specified in the specifications covering the material or product being tested, the

³ “Thermodynamic Properties of the NaCl + H₂O system II. Thermodynamic Properties of NaCl(aq), NaCl·2H₂O(cr), and Phase Equilibria,” *Journal of Physics and Chemistry Reference Data*, Vol 21, No. 4, 1992.

test shall be continuous for the duration of the entire test period. Continuous operation implies that the chamber be closed except for the short daily interruptions necessary to inspect, rearrange, or remove test specimens, to check and replenish the solution in the reservoir, and to make necessary recordings as described in 4.3.1, 4.3.2, and Section 9. (See Note 8.)

NOTE 8—Operations should be so scheduled that the cumulative maximum time for these interruptions are held to 60 min or less per day. It is recommended to have only one interruption per day if possible. If interruption time is longer than 60 min, it should be noted in the test report.

7.3 *Period of Test*—Designate the period of test in accordance with the specifications covering the material or product being tested or as mutually agreed upon between the purchaser and the seller. Exposure periods of multiples of 24 h are suggested.

7.4 *Cleaning of Tested Specimens*—Unless otherwise specified in the specifications covering the material or product being tested, at the end of the test, specimens may be gently washed or dipped in clean running water no warmer than 38°C (100°F) to remove salt deposits from their surface, and then immediately dried. Dry with a stream of clean, compressed air.

NOTE 9—Drying with compressed air may not be desirable for aluminum specimens to be tested for exfoliation corrosion resistance.

8. Evaluation of Results

8.1 Make a careful and immediate examination for the extent of corrosion of the dry test specimens or for other failure as required by the specifications covering the material or product being tested or by agreement between the purchaser and the seller.

9. Report

9.1 Record the following information, unless otherwise prescribed in the specifications covering the material or product being tested:

9.1.1 Type of salt and water used in preparing the salt solution,

9.1.2 All readings of temperature within the exposure zone of the chamber,

9.1.3 Weekly or daily records, see Note 10, (depending on which test annex is being performed) of data obtained from

each fog-collecting device for volume of salt solution collected in millilitres per hour of operation per 80 cm² of horizontal collection area.

9.1.4 Concentration or specific gravity of collected solution and the temperature of that solution when measured. Follow Table 2 for salt concentration and density versus temperature to determine that the sample measured is within specification. Sample to be measured may be a composite sample from multiple fog-collecting devices within a single cabinet, if necessary, to obtain sufficient solution volume for measurement.

9.1.5 pH of collected solution. Sample to be measured may be a composite sample from multiple fog collecting devices within a single cabinet, if necessary, to obtain sufficient solution volume for measurement.

9.1.6 Weekly or daily records, see Note 10, (depending on which test annex is being performed) of data obtained from fog-collecting devices for concentration or specific gravity at 23 ± 3°C (73 ± 5°F) of solution collected (see Note 11) and pH of collected solution. Sample to be measured may be a composite sample from multiple fog-collecting devices (within one test chamber), if necessary to obtain sufficient solution volume for measurement. All records of data obtained for volume of salt solution collected in millilitres per hour per each 80 cm² fog collecting device. (See 4.3.2.)

NOTE 10—Except on Saturday, Sundays, and holidays, when the test is not interrupted for exposing, rearranging, or removing test specimens or to check and replenish the solution in the reservoir(s).

9.1.7 Type of specimen and its dimensions, or number or description of part,

9.1.8 Method of cleaning specimens before and after testing,

9.1.9 Method of supporting or suspending article in the salt spray chamber,

9.1.10 Description of protection used as required in 5.2.4,

9.1.11 Exposure period,

9.1.12 Interruptions in test, cause and length of time, and

9.1.13 Results of all inspections.

NOTE 11—It is also advisable to record the concentration or specific gravity of any atomized salt solution that has not made contact with the test specimen and that was returned to the reservoir.

10. Keywords

10.1 acidic salt spray; corrosion; salt spray

ANNEXES
(Mandatory Information)
A1. ACETIC ACID-SALT SPRAY (FOG) TESTING
A1.1 Salt Solution

A1.1.1 A sodium chloride solution made in accordance with **6.3**.

A1.1.2 Adjust the pH of this solution measured in accordance with Test Method **E70** to range from 3.1 to 3.3 by the addition of acetic acid.

NOTE A1.1—The initial solution may be adjusted to pH of 3.0 to 3.1 with the expectation that the pH of the collected fog will be within the specified limits. Base the adjustment of the initial pH for make-up solution upon the requirements to maintain the required pH of the collected samples. If less than 0.1 or more than 0.3 % of the glacial acetic acid is required to attain the specified pH, the purity of the water or salt, or both may not be satisfactory.

A1.2 Conditions in Saturator Tower

A1.2.1 Make sure the temperature in the saturator tower (bubble tower) is $47 \pm 1^\circ\text{C}$ ($117 \pm 2^\circ\text{F}$).

A1.3 Conditions in the Salt Spray Chamber

A1.3.1 *Temperature* —Maintain the exposure zone of the acetic acid-salt spray fog chamber at $35 \pm 2^\circ\text{C}$ ($95 \pm 3^\circ\text{F}$). Each set point and its tolerance represents an operational control point for equilibrium conditions at a single location in the cabinet which may not necessarily represent the uniformity of conditions throughout the cabinet.

NOTE A1.2—This test is particularly applicable to research studies that have the effect of altering parameters of the electroplating process in connection with decorative chromium plating on steel or zinc die-cast base as well as for the evaluation of the quality of the product. This is true because of the normal duration of the test, which may be as brief as 16 h, but normally runs for 144 to 240 h or more giving ample opportunity for observations at practical intervals of the effects of minor parameter changes.

A2. CYCLIC ACIDIFIED SALT FOG TESTING
A2.1 Salt Solution

A2.1.1 Use a sodium chloride solution made in accordance with **6.3**.

A2.1.2 Adjust the pH of this solution to range from 2.8 to 3.0 by the addition of acetic acid.

A2.2 Conditions in Saturator Tower

A2.2.1 Make sure the temperature in the saturator tower (bubble tower) is $57 \pm 1^\circ\text{C}$ ($135 \pm 2^\circ\text{F}$).

A2.3 Conditions in Salt-Spray Chamber

A2.3.1 *Temperature* —Maintain the temperature in the exposure zone of the salt spray chamber at $49 \pm 2^\circ\text{C}$ ($120 \pm 3^\circ\text{F}$).

A2.3.2 *Humidity* —Although the humidity limits for optimum test conditions have not been determined, operate the salt spray chamber under wet bottom conditions (that is, make sure an inch or so of water is present in the bottom of the box) for most testing. This ensures that the interior of the box does not become dry, a condition that decreases corrosion rate. (The dry bottom is recommended, however, for testing 2000-series aluminum alloys and paint coatings that require a less aggressive environment.)⁴

A2.3.3 *Cabinet* —Equip the chamber with a timing device that can be used for the following 6-h repetitive cycles: $\frac{3}{4}$ -h spray; 2-h dry-air purge; and $\frac{3}{4}$ -h soak at high relative humidity.

A2.3.4 *Purge*—Purging of the fog atmosphere immediately after spraying is the most unique feature of this test. Dry all droplets of water on the specimens and dry the corrosion products so that they are of a white, rather than a damp gray appearance. Perform this by electrically switching the air-flow to bypass the saturator tower and aspirator nozzle and allowing it to enter directly into the test chamber for 120 min at an angle that sweeps the fog out of the peaked lid of the cabinet. This reduces the relative humidity from 40 to 7 %, depending on the climatic conditions of the ambient air. After purging, the specimens remain in the closed cabinet until the next spray cycle. Since most testing requires a wet bottom, the humidity gradually increases from 65 to 95 % during this period.

A2.3.5 *Atomization and Quantity of Fog*—Collect the fog in a special continuous spray run of at least 16 h periodically between test runs. Determine the proper consumption of solution by monitoring solution level in the collection devices.

⁴ Personal communication, Alcoa Technical Center, New Kensington, PA.

A3. ACIDIFIED SYNTHETIC SEA WATER (FOG) TESTING

A3.1 Salt Solution

A3.1.1 Use a synthetic sea salt solution made in accordance with 6.2, with the addition of 10 mL of glacial acetic acid per litre of solution.

A3.1.2 Adjust the pH of the salt solution between 2.8 and 3.0.

A3.2 *Conditions in Saturator Tower*—Make sure the temperature in the saturator tower (bubble tower) is $47 \pm 1^\circ\text{C}$ ($117 \pm 2^\circ\text{F}$) if cabinet temperature is 35°C (95°F); and $57 \pm 1^\circ\text{C}$ ($135 \pm 2^\circ\text{F}$) if cabinet temperature is 49°C (120°F).

A3.3 Conditions in Salt Spray Chamber

A3.3.1 *Temperature* —The temperature in the exposure zone of the salt spray chamber may vary to suit the material being tested. The specifications that cover the material or product being tested define the temperature or the temperature may be mutually agreed upon between the purchaser and the seller. See Note A3.1 for recommended exposure zone temperatures for some materials.

NOTE A3.1—This test is particularly applicable to production control of exfoliation-resistant heat treatments for the 2000, 5000, and 7000-series aluminum alloys.⁵ It is also applicable to developmental studies of varying heat treatment parameters to determine effect on corrosion behavior. For this purpose, a temperature of 49°C (120°F) is recommended for the exposure zone. For testing organic coatings on various metallic substrates, an exposure zone temperature of 24 to 35°C (75 to 95°F) may be used since temperatures in excess of 35°C frequently result in paint blistering.

A3.3.2 *Humidity* —Although the humidity limits for optimum test conditions have not been determined, results of an interlaboratory testing program indicate that it is necessary to operate under wet bottom conditions (that is, an inch or so of water should always be present in the bottom of the box). This ensures that the interior of the box does not become dry, a condition that will decrease the corrosion rate.

A3.3.3 *Cabinet* —Equip the cabinet with a timing device that can be used for the following cycle: 30-min spray followed by 90-min soak at above 98 % relative humidity.

⁵ Ketcham, S. J., and Jeffrey, P. W., “Localized Corrosion-Cause of Metal Failure,” ASTM STP 516, ASTM, 1973, pp. 273–302.

A4. SALT/SO₂ SPRAY (FOG) TESTING

A4.1 This test consists of spraying salt fog with introduction of SO₂ gas directly into the chamber periodically.

A4.2 Salt Solution

A4.2.1 Define the salt solution by using the specifications covering the material or product being tested or upon mutual agreement between the purchaser and the seller.

A4.2.2 If synthetic sea salt is specified, prepare it in accordance with 6.2.

A4.2.3 If sodium chloride is specified, prepare it in accordance with 6.3.

A4.3 Conditions in Saturator Tower

A4.3.1 Make sure the temperature in the saturator tower (bubble tower) is $47 \pm 1^\circ\text{C}$ ($117 \pm 2^\circ\text{F}$).

A4.4 Conditions in the Salt Spray Chamber

A4.4.1 *Temperature* —Maintain the exposure zone of the salt spray chamber at $35 \pm 2^\circ\text{C}$ ($95 \pm 3^\circ\text{F}$).

A4.4.2 *SO₂ Gas*—Equipment and materials required for addition of SO₂ to cabinet are as follows:

A4.4.2.1 Cylinder of SO₂ gas.

A4.4.2.2 Flowmeter capable of measuring SO₂ gas flow of $1 \text{ cm}^3/\text{min}\text{-ft}^3$ of cabinet volume ($35 \text{ cm}^3/\text{min}\text{-m}^3$); also constructed of materials inert to SO₂ gas.

A4.4.2.3 Timer.

A4.4.2.4 Two-way solenoid valve fabricated of materials inert to SO₂ gas.

A4.4.2.5 Tubing and fittings for SO₂ line of materials inert to SO₂ gas. A schematic of the SO₂ line is shown in Fig. A4.1.

NOTE A4.1—It is highly desirable to have the SO₂ gas introduced into the chamber in such a way that a uniform dispersion throughout the interior will result. If the cabinet is equipped with a central dispersion tower, holes can be drilled in the poly(methyl methacrylate) (PMMA) baffle at the top of the tower so that the gas comes out of eight uniformly spaced ports. There are undoubtedly other means for accomplishing a uniform dispersion of the gas. However, avoid introducing the gas into the chamber through one or two tubes at the side.

A4.4.3 The pH of the collected solution shall range from 2.5 to 3.2.

A4.4.4 *Cycle*—Define the cycle to be used by using the specifications covering the material or product being tested or upon mutual agreement between the purchaser and the seller. Examples of some possible cycles are as follows:

A4.4.4.1 Constant spray with introduction of SO₂ gas for 1 h $4 \times$ a day (every 6 h).

A4.4.4.2 $\frac{1}{2}$ -h salt spray, $\frac{1}{2}$ -h SO₂, 2-h soak.

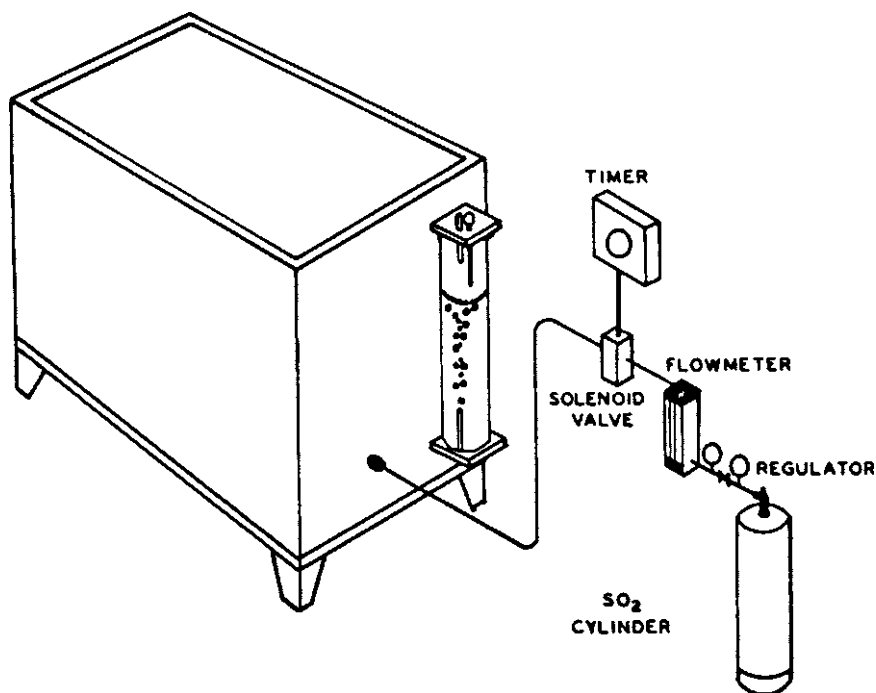

FIG. A4.1 Schematic of SO₂ Line into Salt Fog Cabinet

A5. DILUTE ELECTROLYTE CYCLIC FOG/DRY TEST

A5.1 This test consists of cycles of 1-h dry-off and 1-h fog. The electrolyte is a solution of sodium chloride and ammonium sulfate, and is much more dilute than traditional salt fog. The fog is performed at room temperature, while the dry-off is at elevated temperature. In addition, the spray atomizing air is not saturated with water.

NOTE A5.1—This test is particularly applicable to paints on steel.

A5.2 Salt Solutions

A5.2.1 Prepare an electrolyte solution of 0.05 % sodium chloride and 0.35 % ammonium sulfate by mass. The water and sodium chloride shall meet the purity requirements of Section 6. The ammonium sulfate shall contain not more than 0.3 % total impurities.

A5.3 Conditions in the Salt Fog Chamber

A5.3.1 *Wet/Dry Cycle*—The cycle consists of 1-h fog followed by 1-h dry-off.

NOTE A5.2—Experience indicates that longer cycle times can produce slower degradation.

A5.3.2 *Fog Temperature*—During the fog period, no heating is applied to the cabinet. The fog exposure is at ambient room temperature and conditions.

NOTE A5.3—Ambient conditions shall be an indoor atmosphere with no unusual pollution other than that arising from the test chamber. Such conditions shall be controlled to a temperature of $24 \pm 3^\circ\text{C}$ ($75 \pm 6^\circ\text{F}$) and a relative humidity below 75 %. Different room temperatures can give different results.

A5.3.3 The pH of the collected solution shall range between 5.0 and 5.4 (see 4.3.2 and 6.4).

A5.3.4 *Dry-Off Temperature*—The temperature throughout the exposure zone shall reach and remain at $35 \pm 1.5^\circ\text{C}$ ($95 \pm 3^\circ\text{F}$) within $\frac{3}{4}$ -h of switching from the fog period to the dry period.

A5.3.4.1 The dry-off is achieved by purging the chamber with fresh air, such that within $\frac{3}{4}$ -h all visible moisture is dried off of the specimens.

A5.4 *Cabinet Modifications*—In order to achieve the temperature changes specified in this annex, modifications or additions to Practice B117 apparatus may be required. These may include:

- A5.4.1 Exposure chamber,
- A5.4.2 Temperature controls,
- A5.4.3 Air flow apparatus,
- A5.4.4 Insulation, and
- A5.4.5 Means for conditioning the heated air in the chamber or water in the jacket.
- A5.4.6 Consult the cabinet manufacturer for any additional information or suggestions, or both.

A5.5 *Saturation Tower*—This test does not use humidified air. Use one of the following methods to avoid humidifying the air:

A5.5.1 Empty the saturation tower and ensure that the tower heaters are turned off, or

A5.5.2 Arrange the spray plumbing so that the atomizing air does *not* go through the saturation tower, but goes directly to the spray nozzle.

NOTE A5.4—The cycling from wet to dry subjects the specimens to a range of solution concentrations varying from very dilute during the fog period to very concentrated just before the water dries off completely. Do

not saturate the atomizing air with water, because the purpose of saturation is to help keep the solution at a fixed concentration.

A5.6 *Atomization and Quantity of Fog*—Collect the fog in a special continuous spray run of at least 16 h, performed between test runs. The regular spray periods of 1 h are not long enough for collecting sufficient fog to make accurate determinations of deposition rate. See 4.3.2 for instructions on fog collection.

APPENDIXES

(Nonmandatory Information)

X1. SYNOPSIS TEXT CORRELATING WITH Annex A1

X1.1 “Spray” (Fog) Solution

X1.1.1 5 ± 1 parts by mass of Sodium Chloride in 95 parts by mass of Specification D1193 Type IV water. Adjust pH of solution from 3.1 to 3.3 by the addition of glacial acetic acid. (See Fig. X1.1.)

X1.1.2 Maintain the exposure zone temperature at $35 \pm 2^\circ\text{C}$ ($95 \pm 3^\circ\text{F}$). Each set point and its tolerance represents an

operational control point for equilibrium conditions at a single location in the cabinet which may not necessarily represent the uniformity of conditions throughout the cabinet.

X1.1.3 Fog at a rate of 1.0 to 2.0 mL/h per 80 cm² of horizontal collection area.

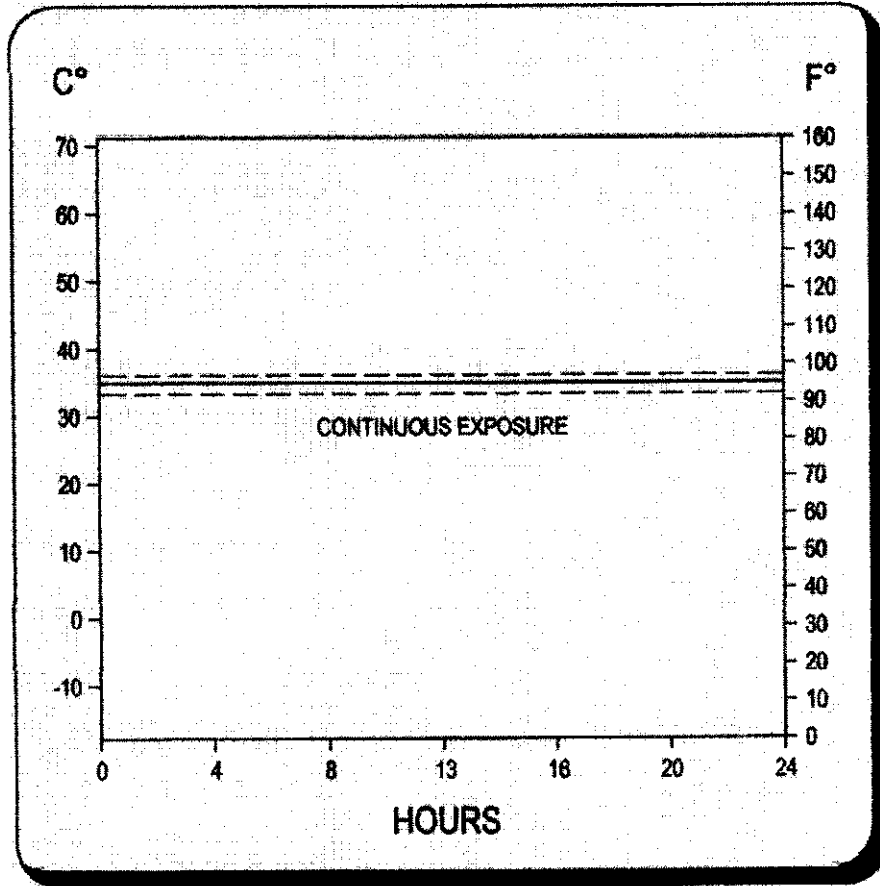

NOTE 1—Dashed chart lines indicate temperature tolerance limits.

NOTE 2—Reprinted with permission.

FIG. X1.1 Continuous Acetic Acid-Salt Spray (Fog) Testing

X2. SYNOPSIS TEXT CORRELATING WITH Annex A2

X2.1 “Spray” (Fog) Solution

X2.1.1 5 ± 1 parts by mass of Sodium Chloride in 95 parts by mass of Specification D1193 Type IV water. Adjust pH of solution from 2.8 to 3.0 by the addition of glacial acetic acid. (See Fig. X2.1.)

X2.1.2 Exposure zone temperature to be held at $49 \pm 2^\circ\text{C}$ ($120 \pm 3^\circ\text{F}$). Operate with wet bottom condition. Saturate/Bubble/Humidifying Tower at $57 \pm 1^\circ\text{C}$ ($135 \pm 2^\circ\text{F}$). Each set point and its tolerance represents an operational control point

for equilibrium conditions at a single location in the cabinet which may not necessarily represent the uniformity of conditions throughout the cabinet.

X2.1.3 Fog at a rate of 1.0 to 2.0 mL/h per 80 cm² of horizontal collection area, based on a separate continuous fog cycle of at least 16 h.

X2.1.4 The test is 6-h repetitive cycles: $\frac{3}{4}$ -h spray; 2-h dry-air purge; and $3\frac{1}{4}$ -h soak at high relative humidity.

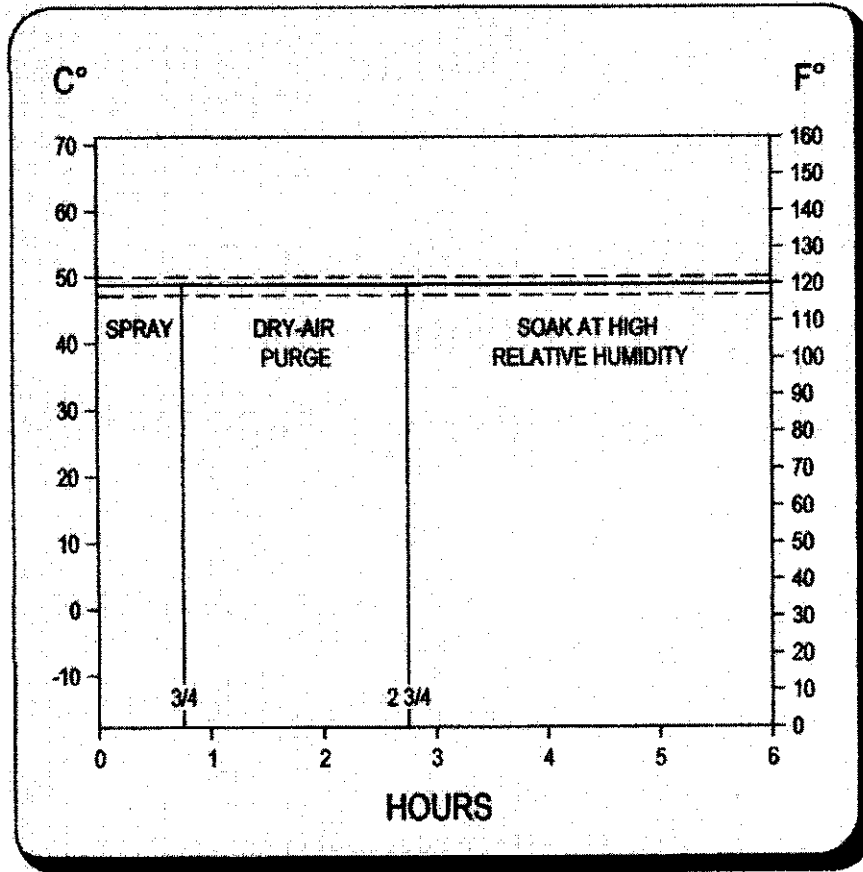

NOTE 1—Dashed chart lines indicate temperature tolerance limits.

NOTE 2—Reprinted with permission.

FIG. X2.1 Cyclic Acidified Salt Fog Testing

X3. SYNOPSIS TEXT CORRELATING WITH Annex A3

X3.1 “Spray” (Fog) Solution

X3.1.1 42 g of synthetic sea salt and 10 mL of glacial acetic acid per litre of solution using Specification D1193 Type IV water. Adjust the pH of solution to between 2.8 and 3.0. Practice D1141 states that, to adjust pH, use 10% Sodium Hydroxide (NaOH) solution. (See Fig. X3.1.)

X3.1.2 Exposure zone temperature may vary to suit material and ranges from 24 to 49 ± 2°C (75 to 120 ± 3°F), with wet bottom configuration. Each set point and its tolerance repre-

sents an operational control point for equilibrium conditions at a single location in the cabinet which may not necessarily represent the uniformity of conditions throughout the cabinet.

X3.1.3 Fog at a rate of 1.0 to 2.0 mL/h per 80 cm² of horizontal collection area, based on a separate continuous fog cycle of at least 16 h.

X3.1.4 The cycle is 2 h repetitive cycles: ½-h spray with 1½-h soak at or above 98 % relative humidity.

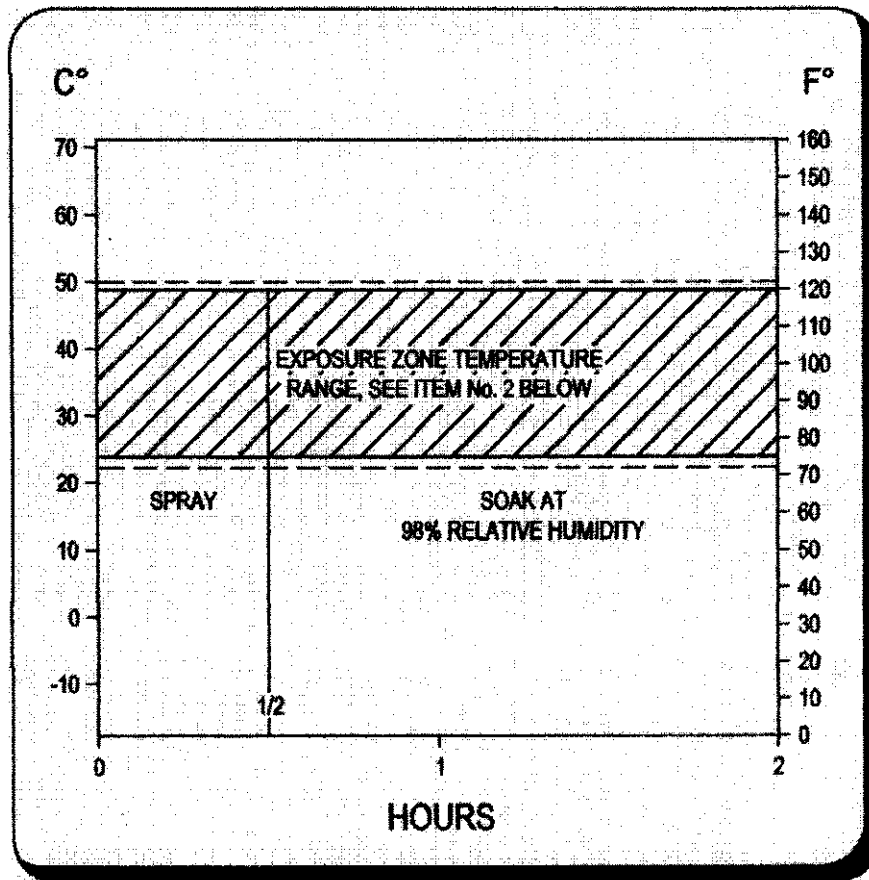

NOTE 1—Dashed chart lines indicate temperature tolerance limits.

NOTE 2—Reprinted with permission.

FIG. X3.1 Cyclic Acidified Synthetic Sea Water (Fog) Testing

**X4. CONSTANT SPRAY (FOG) WITH INTRODUCTION OF SO₂ GAS FOR 1 H FOUR TIMES A DAY (EVERY 6 H)
(SYNOPSIS TEXT CORRELATING WITH Annex A4)**

X4.1 “Spray” (Fog) Solution

X4.1.1 Either 1) 5 parts of NaCl by mass in 95 parts by mass of Specification D1193 Type IV water, or 2) 42 g of synthetic sea salt in accordance with Practice D1141 per litre of solution. Practice D1141 states that to adjust pH use 10% Sodium Hydroxide (NaOH) solution. (See Fig. X4.1.)

X4.1.2 Exposure zone temperature to be held constant at 35 ± 2°C (95 ± 3°F). Each set point and its tolerance represents an operational control point for equilibrium conditions at a single location in the cabinet which may not necessarily represent the uniformity of conditions throughout the cabinet.

X4.1.3 Fog at a rate of 1.0 to 2.0 mL/h per 80 cm² of horizontal collection area, based on a separate continuous fog cycle of at least 16 h.

X4.1.4 pH 2.5 to 3.2 of collected solution.

X4.1.5 The test is a 6-h repetitive cycle: Constant salt fog with SO₂ gas introduction for the last 1 h of each 6 h cycle. SO₂ gas flow is 1 cm³/min-ft³ (35 cm³/min-m³) of chamber volume.

X4.1.6 The SO₂ gas is injected into the chamber by a gas dispersion ring or other means to aid a uniform dispersion of gas throughout the chamber.

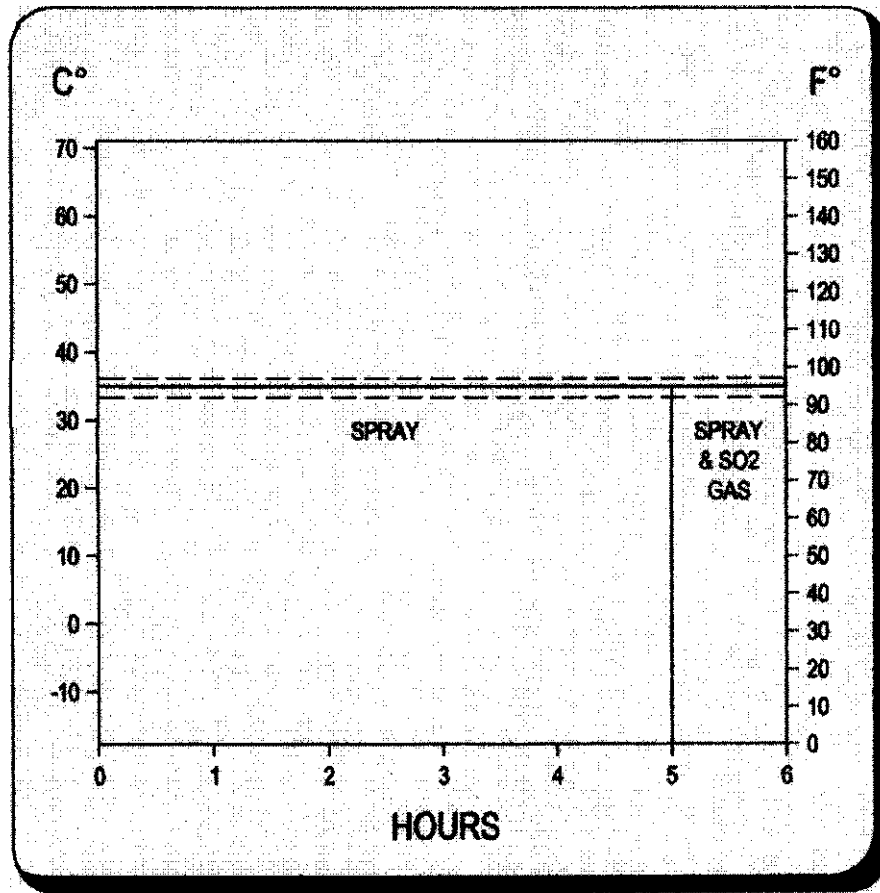

NOTE 1—Dashed chart lines indicate temperature tolerance limits.

NOTE 2—Reprinted with permission.

FIG. X4.1 Cyclic Salt/SO₂ Spray (Fog) Testing (Example X4.1.1)

**X5. 3 H REPETITIVE CYCLE: ½-H SPRAY, ½-H SO₂, AND 2-H SOAK
(SYNOPSIS TEXT CORRELATING WITH Annex A4)**

X5.1 “Spray” (Fog) Solution

X5.1.1 Either 1) 5 parts of NaCl by mass in 95 parts by mass of Specification D1193 Type IV water, or 2) 42 g of synthetic sea salt in accordance with Practice D1141 per litre of solution. Practice D1141 states that to adjust pH use 10% Sodium Hydroxide (NaOH) solution. (See Fig. X5.1.)

X5.1.2 Exposure zone temperature to be held constant at 35 ± 2°C (95 ± 3°F). Each set point and its tolerance represents an operational control point for equilibrium conditions at a single location in the cabinet which may not necessarily represent the uniformity of conditions throughout the cabinet.

X5.1.3 Fog at a rate of 1.0 to 2.0 mL/h per 80 cm² of horizontal collection area, based on a separate continuous fog cycle of at least 16 h.

X5.1.4 pH 2.5 to 3.2 of collected solution.

X5.1.5 The test is 3 h repetitive cycles: ½-h (fog) spray; ½-h SO₂; and 2-h soak. SO₂ gas flow is 1 cm³/min-ft³ (35 cm³/min-m³) of chamber volume.

X5.1.6 The SO₂ gas is injected into the chamber by a gas dispersion ring or other means to aid a uniform dispersion of gas throughout the chamber.

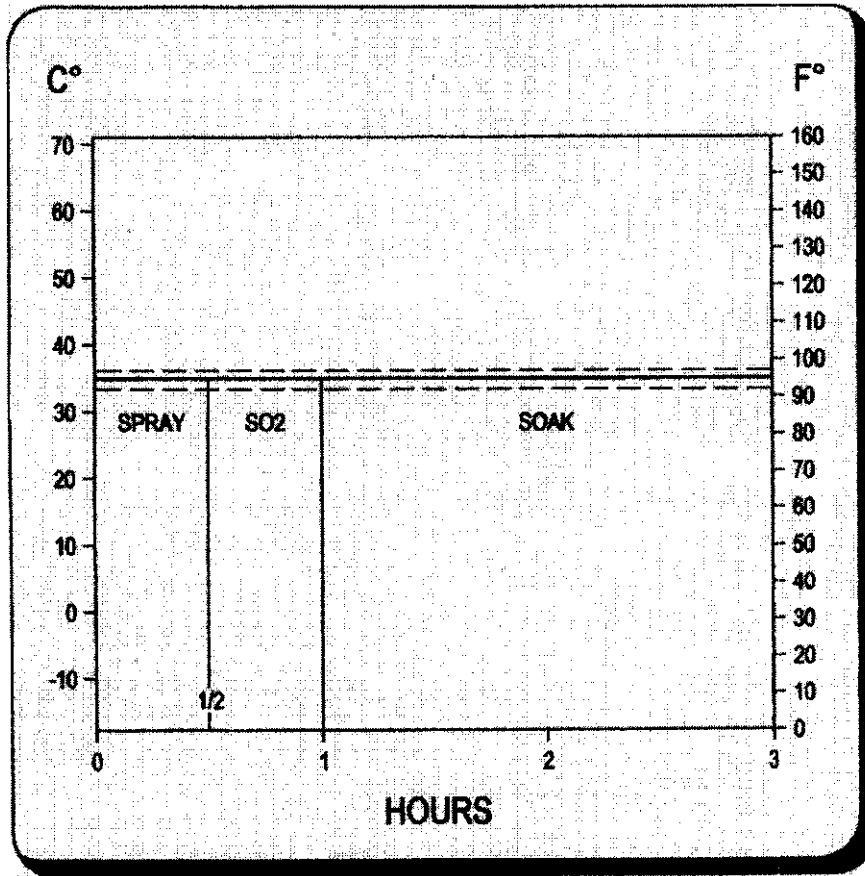

NOTE 1—Dashed chart lines indicate temperature tolerance limits.

NOTE 2—Reprinted with permission.

FIG. X5.1 Cyclic Salt/SO₂ Spray (Fog) Testing (Example X5.1.1)

**X6. 2 H REPETITIVE CYCLE: 1-H SPRAY AND 1-H DRY OFF
(SYNOPSIS TEXT CORRELATING WITH Annex A5)**

X6.1 “Spray” (Fog) Solution

X6.1.1 0.05 % sodium chloride and 0.35 % ammonium sulfate by mass in Specification D1193 Type IV water. (See Fig. X6.1.)

X6.1.2 The test is 2-h repetitive cycles: 1-h spray with exposure zone temperature at ambient room temperature of 24 ± 3°C (75 ± 6°F); and 1-h dry off at 35 ± 2°C (95 ± 3°F). The dry off temperature must reach and remain at 35 ± 2°C (95 ± 3°F) within ¾-h of switching from spray. The dry off is achieved by purging with fresh air such that within ¾-h all

visible moisture is dried off the specimens. Each set point and its tolerance represents an operational control point for equilibrium conditions at a single location in the cabinet which may not necessarily represent the uniformity of conditions throughout the cabinet.

X6.1.3 Spray fog atmosphere at a rate of 1.0 to 2.0 mL/h per 80 cm² of horizontal collection area, based on a separate continuous fog cycle of at least 16 h. The spray atomizing air is not saturated with water.

X6.1.4 pH 5.0 to 5.4 of collected solution.

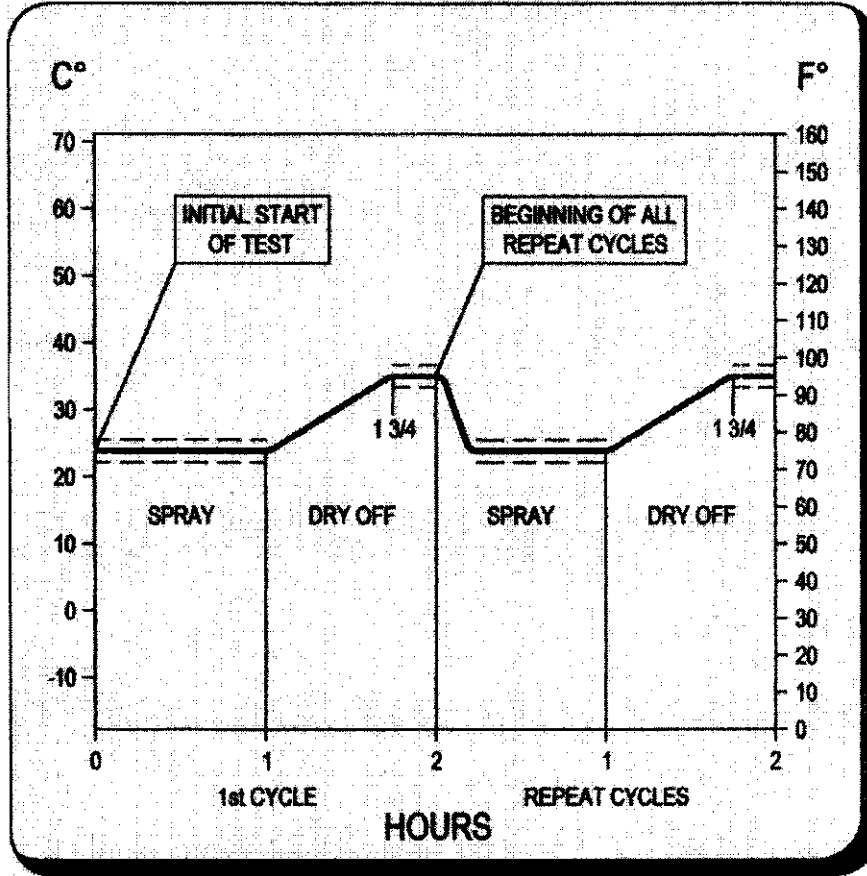

NOTE 1—Dashed chart lines indicate temperature tolerance limits.

NOTE 2—Temperature changes illustrated are pictorial representations only and are not based on actual tests.

NOTE 3—Reprinted with permission.

FIG. X6.1 Dilute Electrolyte Cyclic Fog/Dry Test

ASTM International takes no position respecting the validity of any patent rights asserted in connection with any item mentioned in this standard. Users of this standard are expressly advised that determination of the validity of any such patent rights, and the risk of infringement of such rights, are entirely their own responsibility.

This standard is subject to revision at any time by the responsible technical committee and must be reviewed every five years and if not revised, either reapproved or withdrawn. Your comments are invited either for revision of this standard or for additional standards and should be addressed to ASTM International Headquarters. Your comments will receive careful consideration at a meeting of the responsible technical committee, which you may attend. If you feel that your comments have not received a fair hearing you should make your views known to the ASTM Committee on Standards, at the address shown below.

This standard is copyrighted by ASTM International, 100 Barr Harbor Drive, PO Box C700, West Conshohocken, PA 19428-2959, United States. Individual reprints (single or multiple copies) of this standard may be obtained by contacting ASTM at the above address or at 610-832-9585 (phone), 610-832-9555 (fax), or service@astm.org (e-mail); or through the ASTM website (www.astm.org). Permission rights to photocopy the standard may also be secured from the ASTM website (www.astm.org/COPYRIGHT/).